

TRBoxter 800 kg - 10 m/min, low voltage control with 1 speed, three phase

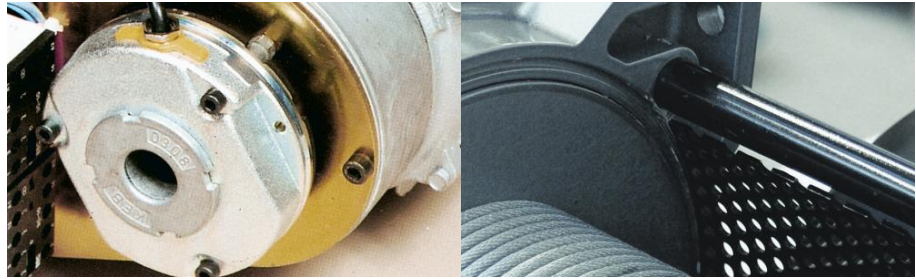

Compact electric winch 800 kg. Range of multifunctional electric winch offering many rope attachments, rope outlets and options.

Use:

- Lifting and hauling/pulling operations
- High operating factor
- Industry
- Building and public works
- Integration into many types of devices, cranes...
- Pulling carriages or wagons with a two-way system
- Installation and extraction of parts in ovens
- Hanging chandeliers
- Boat haulage
- Doors lifting, traps opening
- Material lifts
- Stage industry
- Swimming pool roofs...

Comply with Machines Directive 2006/42/EC and standard NF E N 14492-1.

Technical properties

- Welded steel drum protected by perforate plate, adjustable according to the outlet of the rope. Large flanges for a large rope capacity.
- Reliable and very safe cable clamp. Caged nut for winch multi-position fixing.
- Aluminium casing.
- Robust and compact, it benefits of a high operating factor.
- Asynchronous, three phase motor 230/400 V - 50 Hz. P = 2,2 kW.
- The low voltage control protects the user from electrical risks. It makes it possible to operate a wide range of options: from limit switch to radio control, including a load limiter and a rope slack switch...
- Reliable electronic and electric components.
- Very low voltage, 24 V remote control with socket, IP 65 protection.
- Limit switch obligatory when lifting.
- 24 V direct current electromagnetic brake.
- Electrical equipment under sealed cover.
- Reducer sealed in oil bath with helical gears.
- Fixation points identical to the TRB model allowing old TRB to be replaced.
- Lengthened drum models: standard length of drum and drum capacity x 1,5.
- Available options: rope press-roller, grooved drum, specific paint, chassis, drum length on request, rain cover, timer, tarpauline cover...

Technical characteristics of TRBoxter 800 kg - 10 m/min, low voltage control with 1 speed, three phase

References	TRBOXTER0803BT1
Capacity 1st layer kg	950
Capacity top layer kg	800
Nb of layers	3
Wire rope cap. 1st layer m	16,5
Max. rope capacity m	59
Wire rope Ø mm	8
Fixed speed 1st layer m/min	8,7
Fixed speed top layer m/min	10,3
FEM	1Bm
Motor kW	2,2
Power	3Ph-230/400V
Weight (without wire rope) kg	100

Dimensions

References	TRBOXTER0803BT1
A mm	554
B mm	304
C mm	107,5
D mm	Ø 159
E mm	318
F mm	Ø 12,5
L (with limit switch) mm	516
L (without limit switch) mm	507
G mm	246
H mm	332,5
I mm	62
J mm	29
K mm	495,5
M mm	152
N mm	152
T mm	290

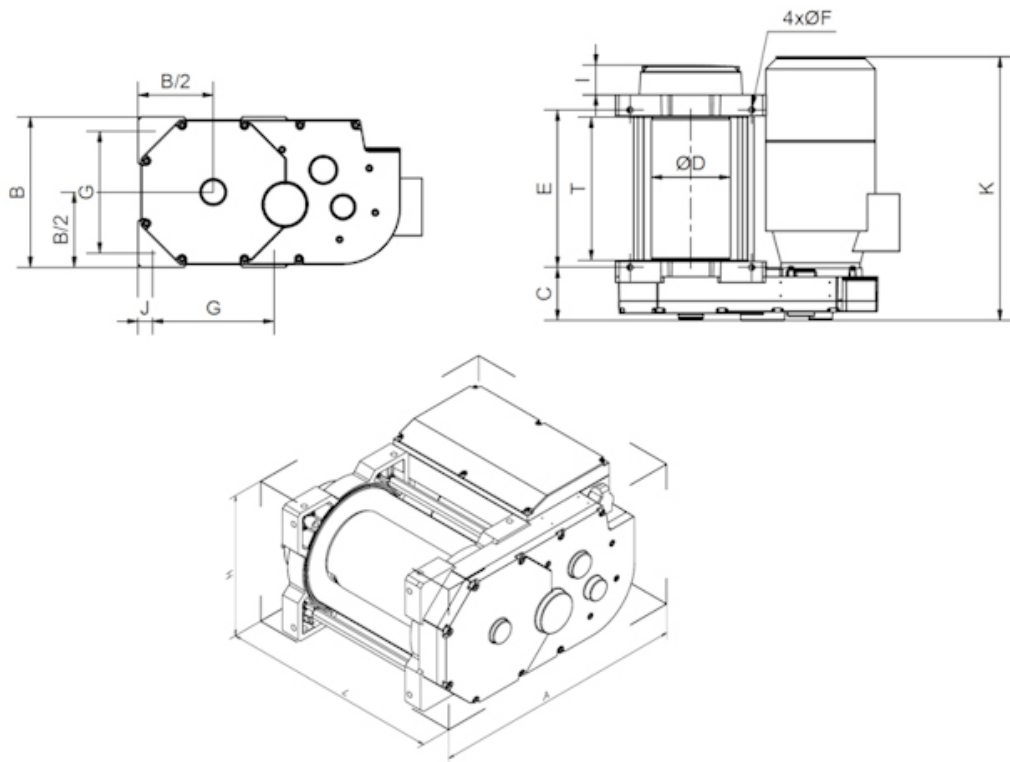

Technical characteristics of the other models of the range

References	TRBOXTER251BT9	TRBOXTER251BT14	TRBOXTER251BT21	TRBOXTER503BT4	TRBOXTER351BT9
Capacity 1st layer kg	290	290	290	600	400
Capacity top layer kg	250	250	250	500	350
Nb of layers	3	3	3	3	3
Wire rope cap. 1st layer m	16	16	16	12	16
Max. rope capacity m	56	56	56	42	56
Wire rope Ø mm	5	5	5	7	5
Fixed speed 1st layer m/min	8,1	13,3	19,8	4	8,1
Fixed speed top layer m/min	9,4	15,4	23	4,9	9,4
FEM	1Am	1Am	1Am	1Bm	1Bm
Motor kW	0,75	0,75	1,1	0,75	0,75
Power	1Ph-230V	1Ph-230V	1Ph-230V	3Ph-230/400V	1Ph-230V
Weight (without wire rope) kg	49	49	51	49	49

References	TRBOXTER351BT14	TRBOXTER353BT26	TRBOXTER501BT11	TRBOXTER503BT21	TRBOXTER0603BT05
Capacity 1st layer kg	400	400	600	600	750
Capacity top layer kg	350	350	500	500	600
Nb of layers	3	3	3	3	4
Wire rope cap. 1st layer m	16	16	12	12	19
Max. rope capacity m	56	56	42	42	93
Wire rope Ø mm	5	5	7	7	7
Fixed speed 1st layer m/min	13,3	25,7	10	20	4,8
Fixed speed top layer m/min	15,4	29,8	12,2	24,2	6
FEM	1Bm	1Bm	1Bm	1Bm	1Am
Motor kW	1,1	2,2	1,1	2,2	0,75
Power	1Ph-230V	3Ph-230/400V	1Ph-230V	3Ph-230/400V	3Ph-230/400V
Weight (without wire rope) kg	51	59	51	59	88

References	TRBOXTER0603BT10	TRBOXTER603BT15	TRBOXTER0603BT20	TRBOXTER0603BT30	TRBOXTER0803BT05
Capacity 1st layer kg	750	750	750	750	950
Capacity top layer kg	600	600	600	600	800
Nb of layers	4	4	4	4	3
Wire rope cap. 1st layer m	19	19	19	19	16,5
Max. rope capacity m	93	93	93	93	59
Wire rope Ø mm	7	7	7	7	8
Fixed speed 1st layer m/min	8,8	14,9	17,9	25,5	4,3
Fixed speed top layer m/min	11	18,6	22,5	31,9	5,2
FEM	1Am	1Am	1Am	1Am	3Ph-230/400V
Motor kW	1,5	2,2	3	4	1Bm
Power	3Ph-230/400V	3Ph-230/400V	3Ph-230/400V	3Ph-230/400V	1,1
Weight (without wire rope) kg	101	100	104	107	92

References	TRBOXTER0803BT10	TRBOXTER0803BT13	TRBOXTER0803BT17	TRBOXTER0993BT05	TRBOXTER0993BT10
Capacity 1st layer kg	950	950	950	1200	1100
Capacity top layer kg	800	800	800	990	990
Nb of layers	3	3	3	3	2
Wire rope cap. 1st layer m	16,5	16,5	16,5	14,5	14,5
Max. rope capacity m	59	59	59	53	34
Wire rope Ø mm	8	8	8	9	9
Fixed speed 1st layer m/min	8,7	12	15	4,4	8,7
Fixed speed top layer m/min	10,3	14,3	17,8	5,3	10,6
FEM	1Bm	1Bm	1Bm	1Bm	1Bm
Motor kW	2,2	3	4	1,1	2,2
Power	3Ph-230/400V	3Ph-230/400V	3Ph-230/400V	3Ph-230/400V	3Ph-230/400V
Weight (without wire rope) kg	100	104	107	92	100

References	TRBOXTER0993BT13	TRBOXTER0993BT17	TRBOXTER1503BT04	TRBOXTER1503BT09	TRBOXTER253BT43
Capacity 1st layer kg	990	990	1500	1500	290
Capacity top layer kg	990	990	1500	1500	250
Nb of layers	1	1	1	1	3
Wire rope cap. 1st layer m	14,5	14,5	11,5	11,5	16
Max. rope capacity m	14,5	14,5	11,5	11,5	56
Wire rope Ø mm	9	9	11,5	11,5	5
Fixed speed 1st layer m/min	12,1	15,1	4,4	8,8	40,3
Fixed speed top layer m/min	12,1	15,1	4,4	8,8	46,6
FEM	1Bm	1Cm	1Bm	3Ph-230/400V	1Am
Motor kW	3	4	1,5	1Cm	1,1
Power	3Ph-230/400V	3Ph-230/400V	3Ph-230/400V	3	3Ph-230/400V
Weight (without wire rope) kg	104	108	101	104	59

References	TRBOXTER253BT9	TRBOXTER253BT14	TRBOXTER253BT21	TRBOXTER353BT9	TRBOXTER353BT14
Capacity 1st layer kg	290	290	290	400	400
Capacity top layer kg	250	250	250	350	350
Nb of layers	3	3	3	3	3
Wire rope cap. 1st layer m	16	16	16	16	16
Max. rope capacity m	56	56	56	56	56
Wire rope Ø mm	5	5	5	5	5
Fixed speed 1st layer m/min	8,1	13,3	19,8	8,1	13,3
Fixed speed top layer m/min	9,4	15,4	23	9,4	15,4
FEM	1Am	1Am	1Am	1Bm	1Bm
Motor kW	0,75	0,75	1,1	0,75	1,1
Power	3Ph-230/400V	3Ph-230/400V	3Ph-230/400V	3Ph-230/400V	3Ph-230/400V
Weight (without wire rope) kg	49	49	51	49	51

References	TRBOXTER503BT11	TRBOXTER501BT11ST	TRBOXTER503BT11ST
		OCK	OCK
Capacity 1st layer kg	600	600	600
Capacity top layer kg	500	500	500
Nb of layers	3	3	3
Wire rope cap. 1st layer m	12	12	12
Max. rope capacity m	42	42	42
Wire rope Ø mm	7	7	7
Fixed speed 1st layer m/min	10	10	10
Fixed speed top layer m/min	12,2	12,2	12,2
FEM	1Bm	1Bm	1Bm
Motor kW	1,1	1,1	1,1
Power	3Ph-230/400V	1Ph-230V	3Ph-230/400V
Weight (without wire rope) kg	51	51	51



HUCHEZ's advice

Fixation points identical to the TRB model allowing old TRB to be replaced, many rope attachments, rope outlets and options.



HUCHEZ
 4, rue Michel HAMMID
 60420 FERRIERES – France
 ☎ +33 (0) 3 44 51 11 33
 🌐 www.huchez.com
 ✉ contact@huchez.fr



SERVICE CLIENTS
 ATENCIO AL CLIENTE
 KUNDENSERVICE



Pour en savoir plus, n'hésitez pas à nous contacter!
 To know more, please contact us!
 Para más información, póngase en contacto con nosotros!
 Für weitere Informationen können Sie sich gerne an uns wenden!